

Part No. ASU3010-U2-0600-150-D



Type UI30/10.5

Power 6.0 VA

Weight 185g

shipping unit per box: 18 pcs temperature class: ta 50°C/B

Vacuum filled casting

Split bobbin design winding

Dielectric strength 3750Vrms

PART NO	Output ta 50°C/B	Prim.V	Connecting pins	Operating point sec. ± 10%	Connecting pins	No-load voltage V ± 10%
ASU3010-U2-0600-150-D	6.0 W	115	1---3	15V 200.0mA	10---12	20.2V
		115	5---7	15V 200.0mA	14---16	20.2V

According to

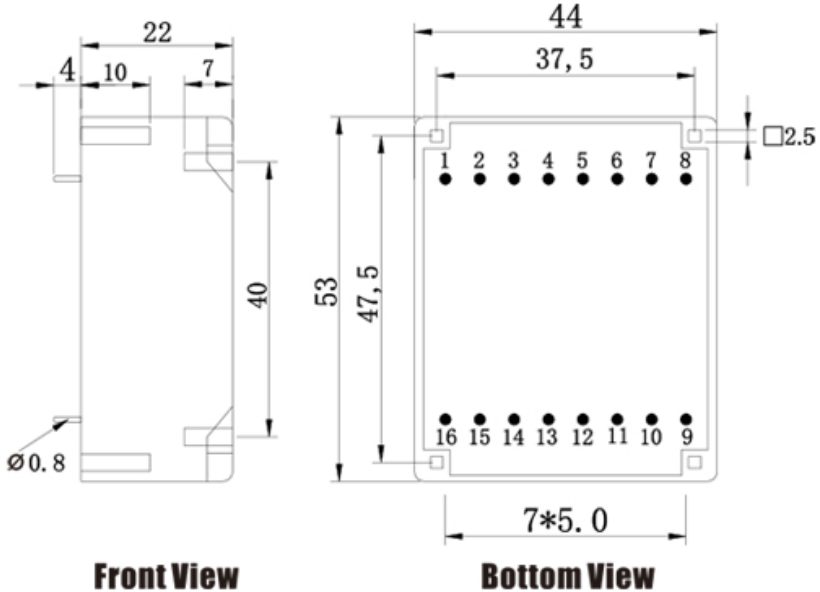

Front View

Bottom View

Tolerances : <10mm ±0.3mm
10--50mm ±0.5mm

Custom-made transformer also will be welcome.

Schematics

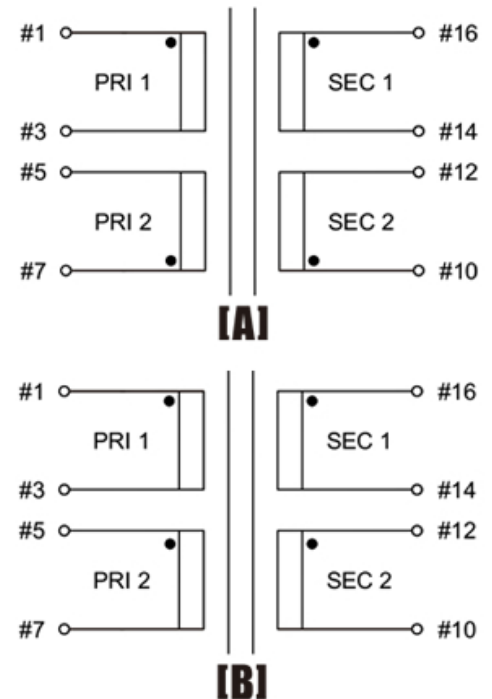

ADD: 699 Fangzhou Road Xiongzhou Town Luhe District 211500 Nanjing City Jiangsu China
TEL: +86 25 57120866 / 57120966 - 8001 FAX:+86 25 57118989
E-mail: asn@asn.cn / asn@asntransformer.com
http://www.asntransformer.com