

Part No. ASU3010-U2-0600-120-D



Type UI30/10.5

Power 6.0 VA

Weight 185g

shipping unit per box: 18 pcs temperature class: ta 50°C/B

Vacuum filled casting

Split bobbin design winding

Dielectric strength 3750Vrms

PART NO	Output ta 50°C/B	Prim.V	Connecting pins	Operating point sec. ± 10%	Connecting pins	No-load voltage V ± 10%
ASU3010-U2-0600-120-D	6.0 W	115	1---3	12V 250.0mA	10---12	16.2V
		115	5---7	12V 250.0mA	14---16	16.2V

According to

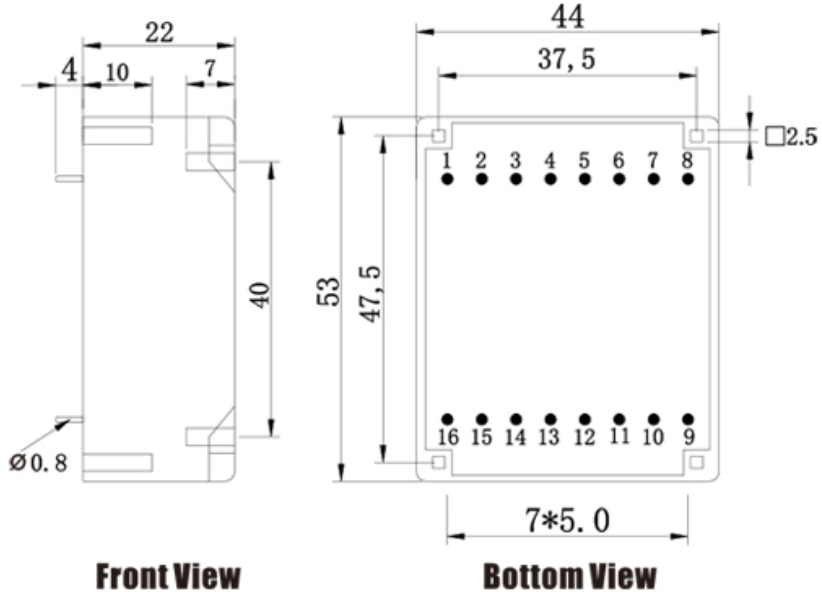

Schematics

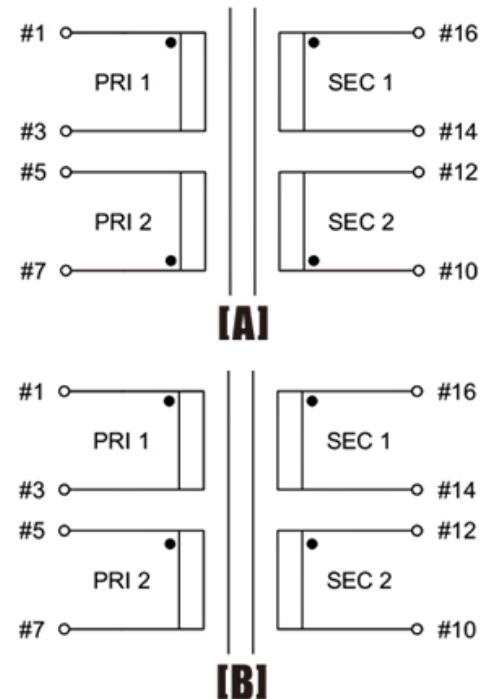

Tolerances : <10mm ±0.3mm  
 10--50mm ±0.5mm  
 Custom-made transformer also will be welcome.



ADD: 699 Fangzhou Road Xiongzhou Town Luhe District 211500 Nanjing City Jiangsu China  
 TEL: +86 25 57120866 / 57120966 - 8001 FAX:+86 25 57118989  
 E-mail: asn@asn.cn / asn@asntransformer.com  
 http://www.asntransformer.com