

Part No. AS5418-U-1600-240-D



Type EI54/18

Power 16.0VA

Weight 440g

shipping unit per box: 10 PCS

temperature class: ta 70°C/B

**Vacuum filled casting**

Split bobbin design winding

**Dielectric strength 4500Vrms**

PART NO	Output ta 70°C/B	Prim.V	Connecting pins	Operating point sec. ± 10%	Connecting pins	No-load voltage V ± 10%
AS5418-U-1600-240-D	16.0W	115	1--7	24V 333.3mA	8--9	30.0V
				24V 333.3mA	13--14	30.0V

According to

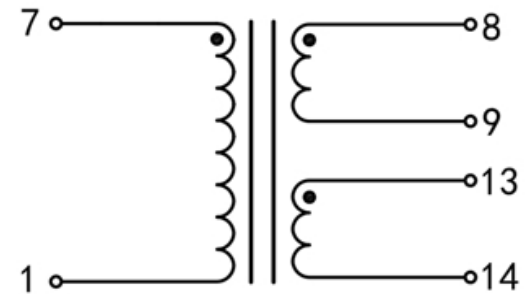
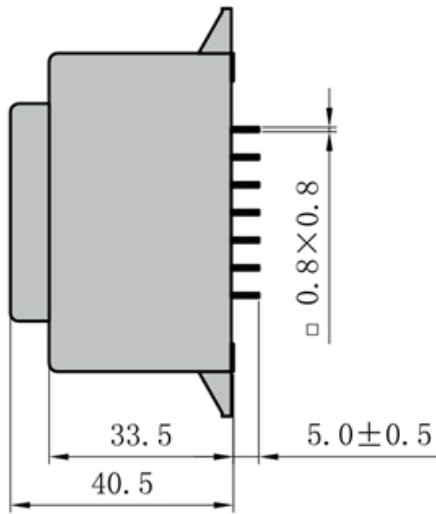
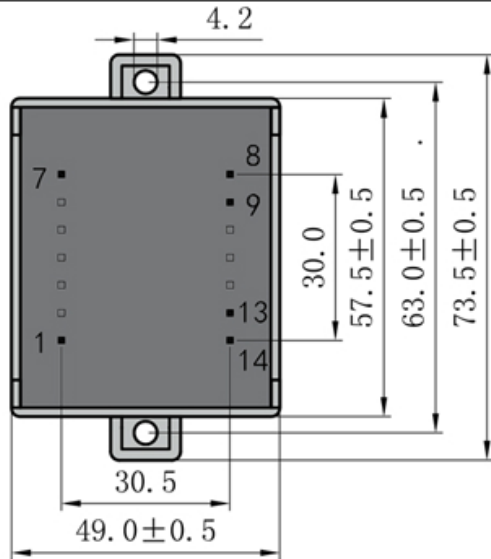

Dimensions with no indication of tolerances: ± 0.3mm  
Custom-made transformer also will be welcome.



ADD: 699 Fangzhou Road Xiongzhou Town Luhe District 211500 Nanjing City Jiangsu China  
TEL: +86 25 57120866 / 57120966 - 8001 FAX: +86 25 57118989  
E-mail: asn@asn.cn / asn@asntransformer.com  
http://www.asntransformer.com