

Part No. AS5418-E-1600-150-D



Type EI54/18

Power 16.0VA

Weight 440g

shipping unit per box: 10 PCS

temperature class: ta 70°C/B

Vacuum filled casting

Split bobbin design winding

Dielectric strength 4500Vrms

PART NO	Output ta 70°C/B	Prim.V	Connecting pins	Operating point sec. ± 10%	Connecting pins	No-load voltage V ± 10%
AS5418-E-1600-150-D	16.0W	230	1--7	15V 533.3mA	8--9	18.8V
				15V 533.3mA	13--14	18.8V

According to

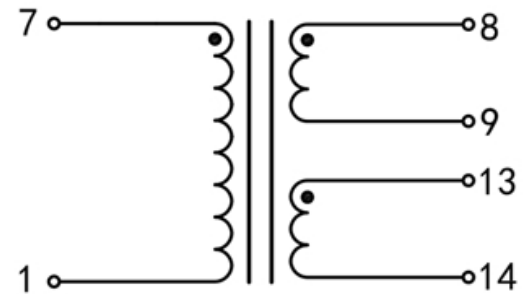
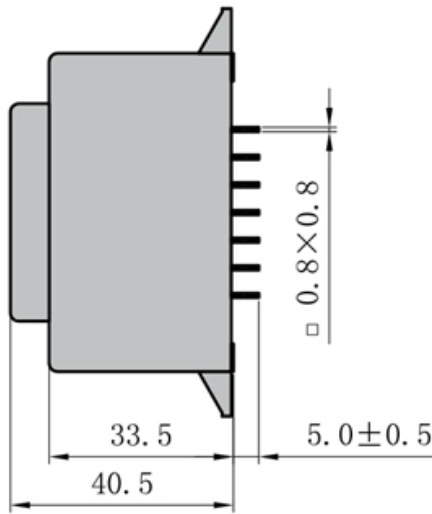
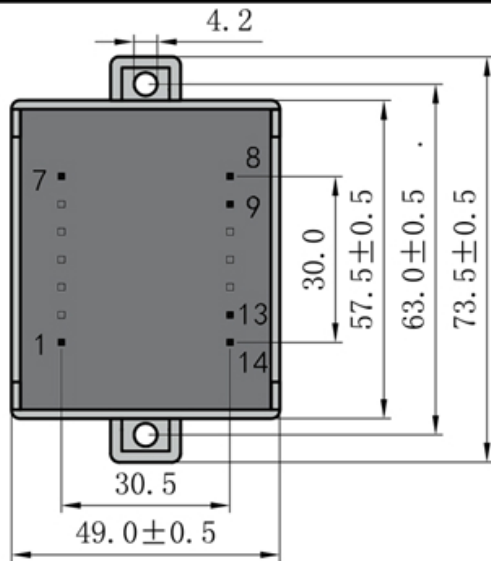

Dimensions with no indication of tolerances: ± 0.3mm
Custom-made transformer also will be welcome.



ADD: 699 Fangzhou Road Xiongzhou Town Luhe District 211500 Nanjing City Jiangsu China
TEL: +86 25 57120866 / 57120966 - 8001 FAX: +86 25 57118989
E-mail: asn@asn.cn / asn@asntransformer.com
http://www.asntransformer.com